

SBC T XTS 5015

CS Italia s.r.l.



Optional su richiesta info@carrellispeciali.it 

SBC T XTS 5015

CS Italia s.r.l.

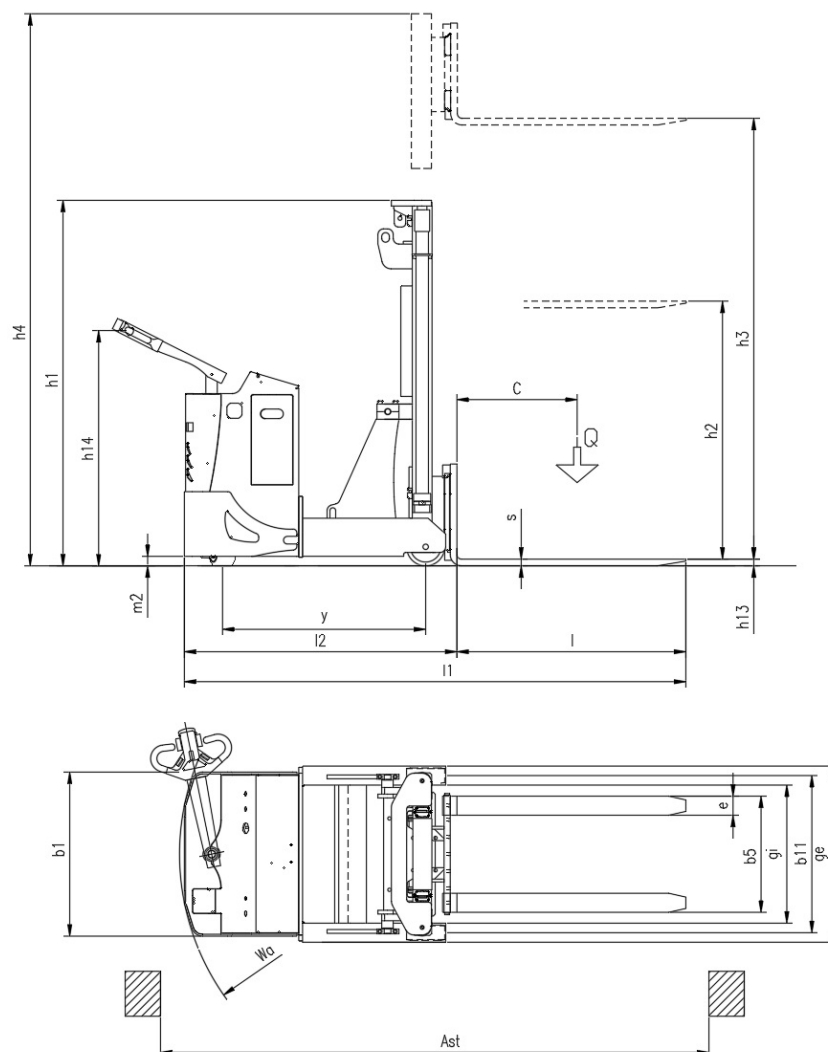

Illustrazioni e dati tecnici non sono impegnativi. Il costruttore si riserva il diritto di apportare modifiche senza preavviso.

Tipologia SBC T XTS 5015

Categoria Contrappesati

General info	1.1	Manufacturer			CSI s.r.l.
	1.2	Model			SBC T XTS 5015
	1.3	Drive			elettrico AC
	1.4	Operator type			a timone
	1.5	Load capacity	Q	t	1.5
	1.6	Load centre	c	mm	600
	1.9	Wheelbase	y	mm	1370
Weights	2.1	Truck weight without battery		Kg	1800
Wheels and chassis	3.1	Wheels			Poliuretano
	3.2	Wheels size front		mm	254x100
	3.3	Wheels size rear		mm	200x80
	3.5	Number of rear/front wheels (x = Traction wheel)			1x/2
	3.7	Rear wheelbase	b11	mm	825
	3.9	Overall width legs	ge	mm	925
	3.10	Inside width legs	gi	mm	725
Dimensions	4.1	Tilt		°	-1/+2
	4.2	Height mast lowered	h1	mm	2500
	4.3	Free lift	h2	mm	1700
	4.4	Lift height	h3	mm	4960
	4.5	Height mast extended	h4	mm	5520
	4.9	Height of tiller (min/max)	h14	mm	975/1535
	4.15	Height forks lowered	h13	mm	40
	4.19	Overall length	l1	mm	2930
	4.20	Length to face of forks	l2	mm	1730
	4.21	Overall width	b1	mm	862
	4.22	Forks dimensions	s/e/l	mm	35/100/1200
	4.23	Carriage forks			FEM 2A
	4.25	Overall forks width size	b5	mm	200-620
	4.31	Ground clearance		mm	40
	4.34	Aisle width	ast	mm	3185
	4.35	Turning radius	wa	mm	1595
Performance	5.1	Travel speed with/without load		Km/h	3/5
	5.2	Lifting speed with/without load		m/s	0,11/0,33
	5.3	Lowering speed with/without load		m/s	0,5/0,2
	5.8	Maximum gradeability with/without load		%	1/3
	5.10	Service brake			elettrico
Motor	6.3	Battery			Piombo acido
	6.4	Battery - voltage and nominal capacity		V/Ah	24V/240 Ah
	6.5	Battery weight		Kg	210
	Dim. batteria	Battery size		mm	810x210x450
Other	8.1	Traction control			proporzionale
	8.4	Noise level driver place			<70