

SBC OB XTS 2512

CS Italia s.r.l.



Optional su richiesta info@carrellispeciali.it ✉

SBC OB XTS 2512

CS Italia s.r.l.

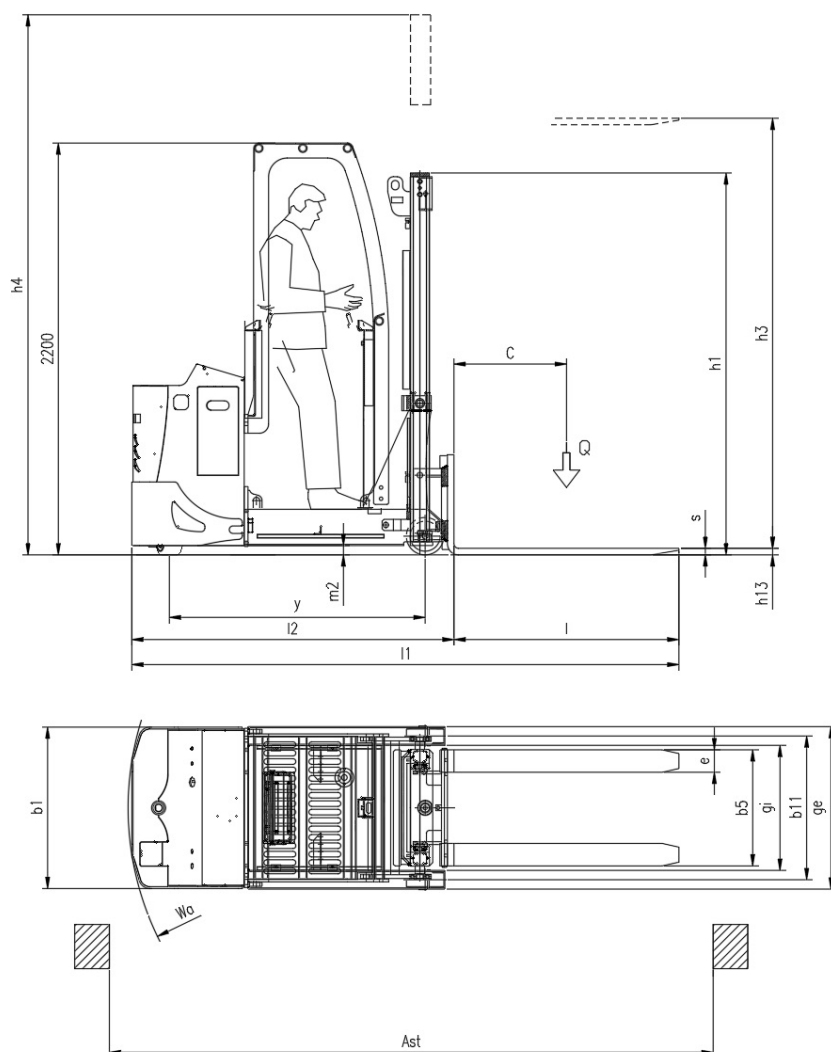

Illustrazioni e dati tecnici non sono impegnativi. Il costruttore si riserva il diritto di apportare modifiche senza preavviso.

Tipologia SBC OB XTS 2512

Categoria Contrappesati

General info	1.1	Manufacturer			CSI s.r.l.
	1.2	Model			SBC OB XTS 2512
	1.3	Drive			elettrico AC
	1.4	Operator type			a volante
	1.5	Load capacity	Q	t	1.2
	1.6	Load centre	c	mm	600
	1.9	Wheelbase	y	mm	1370
Weights	2.1	Truck weight without battery		Kg	1900
Wheels and chassis	3.1	Wheels			Poliuretano
	3.2	Wheels size front		mm	254x100
	3.3	Wheels size rear		mm	200x80
	3.5	Number of rear/front wheels (x = Traction wheel)			1x/2
	3.7	Rear wheelbase	b11	mm	768
	3.9	Overall width legs	ge	mm	868
	3.10	Inside width legs	gi	mm	686
Dimensions	4.1	Tilt		°	-1/+2
	4.2	Height mast lowered	h1	mm	1790
	4.4	Lift height	h3	mm	2460
	4.5	Height mast extended	h4	mm	3120
	4.15	Height forks lowered	h13	mm	40
	4.19	Overall length	l1	mm	2920
	4.20	Length to face of forks	l2	mm	1760
	4.21	Overall width	b1	mm	870
	4.22	Forks dimensions	s/e/l	mm	35/100/1200
	4.31	Ground clearance		mm	50
	4.32	Distanza da piano di lavoro a inizio forca	m2	mm	50
	4.34	Aisle width	ast	mm	3250
	4.35	Turning radius	wa	mm	1585
	Performance	5.1	Travel speed with/without load		Km/h
5.2		Lifting speed with/without load		m/s	0,11/0,33
5.3		Lowering speed with/without load		m/s	0,5/0,2
5.8		Maximum gradeability with/without load		%	2/3
5.10		Service brake			elettrico
Motor	6.1	Traction motor S2 60 min.		Kw	2.5
	6.2	Lift motor S3		Kw	3
	6.3	Battery			Piombo acido
	6.4	Battery - voltage and nominal capacity		V/Ah	24V /240Ah
	6.5	Battery weight		Kg	210
	Dim. batteria	Battery size		mm	810/210/450h
Other	8.1	Traction control			proporzionale
	8.4	Noise level driver place			<70