

**SBC RS 4012**

CS Italia s.r.l.



Optional su richiesta [info@carrellispeciali.it](mailto:info@carrellispeciali.it) ✉

# SBC RS 4012

CS Italia s.r.l.

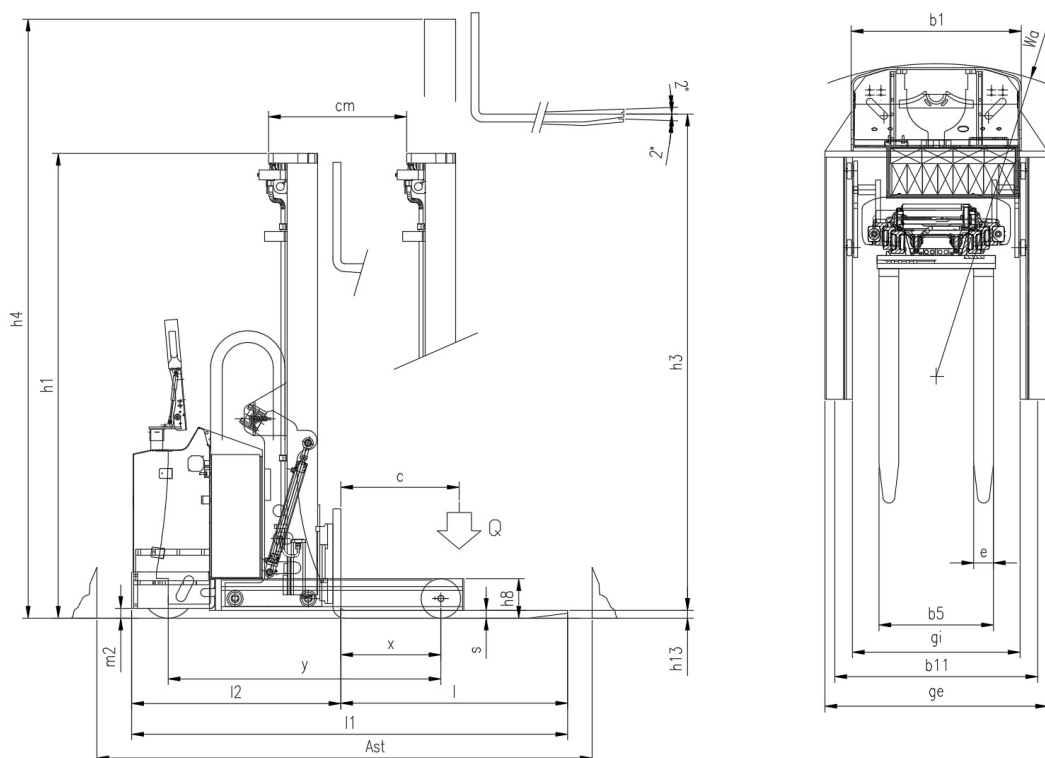

Illustrazioni e dati tecnici non sono impegnativi. Il costruttore si riserva il diritto di apportare modifiche senza preavviso.

**Tipologia** SBC RS 4012

**Categoria** Retrattili

<b>General info</b>	1.1	Manufacturer			CSI s.r.l.
	1.2	Model			SBC RS 4012
	1.3	Drive			elettrico AC
	1.4	Operator type			a timone
	1.5	Load capacity	Q	t	1.2
	1.6	Load centre	c	mm	600
	1.8	Load distance to wheel axle	x	mm	505
	1.9	Wheelbase	y	mm	1385
	<b>Weights</b>				
	2.1	Truck weight without battery		Kg	2150
<b>Wheels and chassis</b>					
	3.1	Wheels			Poliuretano
	3.2	Wheels size front		mm	254x100
	3.3	Wheels size rear		mm	200x80
	3.5	Number of rear/front wheels (x = Traction wheel)			1x/2
	3.7	Rear wheelbase	b11	mm	1030
	3.9	Overall width legs	ge	mm	1130
	3.10	Inside width legs	gi	mm	850
<b>Dimensions</b>					
	4.1	Tilt		°	-1/+2
	4.2	Height mast lowered	h1	mm	2730
	4.4	Lift height	h3	mm	3950
	4.5	Height mast extended	h4	mm	4460
	4.10	Mast raise	cm	mm	700
	4.15	Height forks lowered	h13	mm	40
	4.19	Overall length	l1	mm	2210
	4.20	Length to face of forks	l2	mm	1060
	4.21	Overall width	b1	mm	1130
	4.22	Forks dimensions	s/e/l	mm	35/100/1200
	4.23	Carriage forks			FEM 2A
	4.25	Overall forks width size	b5	mm	200-620
	4.31	Ground clearance		mm	40
	4.32	Distanza da piano di lavoro a inizio forca	m2	mm	40
	4.34	Aisle width	ast	mm	2595
	4.35	Turning radius	wa	mm	1590
<b>Performance</b>					
	5.1	Travel speed with/without load		Km/h	5/6
	5.2	Lifting speed with/without load		m/s	0,11/0,33
	5.3	Lowering speed with/without load		m/s	0,5/0,2
	5.8	Maximum gradeability with/without load		%	1/3
	5.10	Service brake			elettrico
<b>Motor</b>					
	6.1	Traction motor S2 60 min.		Kw	2.5
	6.2	Lift motor S3		Kw	3
	6.3	Battery			Piombo acido
	6.4	Battery - voltage and nominal capacity		V/Ah	24V /250Ah
	6.5	Battery weight		Kg	220
	Dim. batteria	Battery size		mm	650/245/610h
<b>Other</b>					
	8.1	Traction control			proporzionale
	8.4	Noise level driver place			<70

